

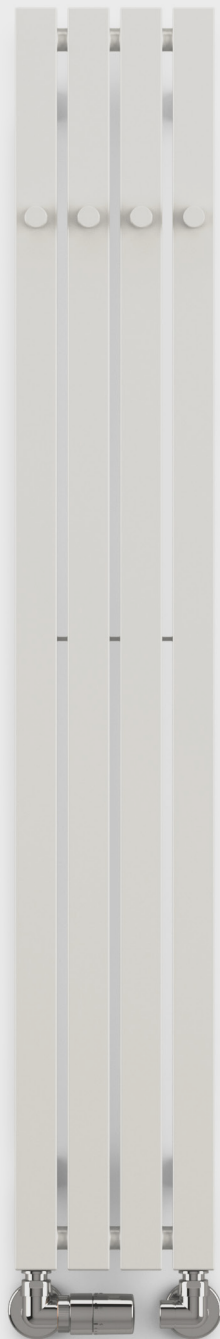

**TERMA**  
SINCE 1990



# TRP HANGER





# AVAILABLE SIZES

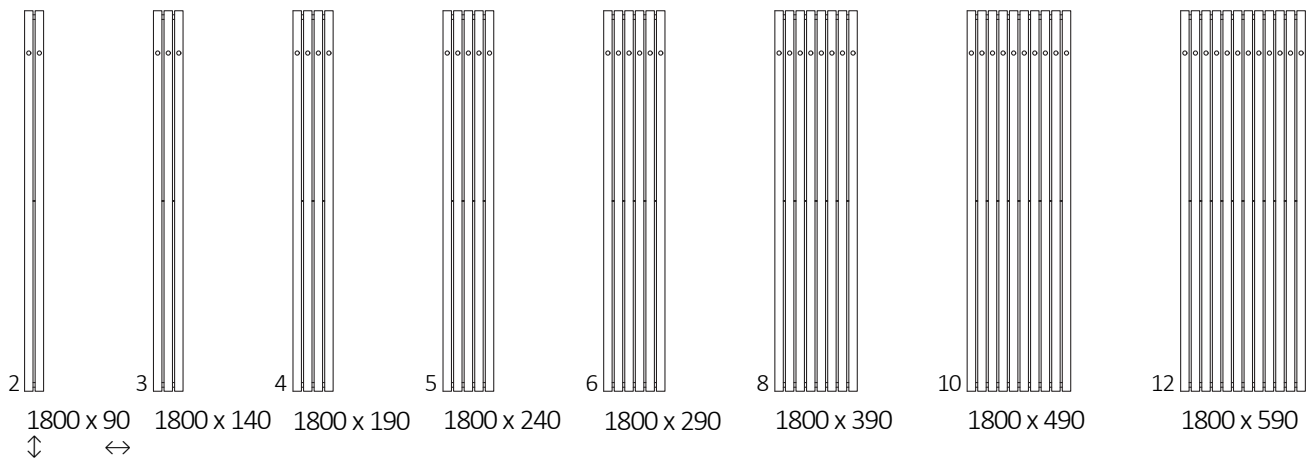
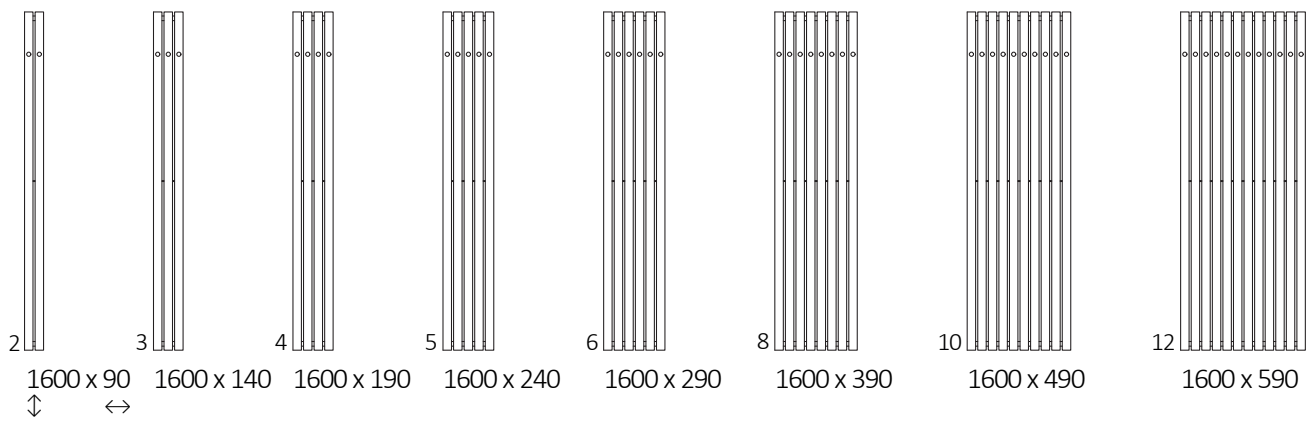
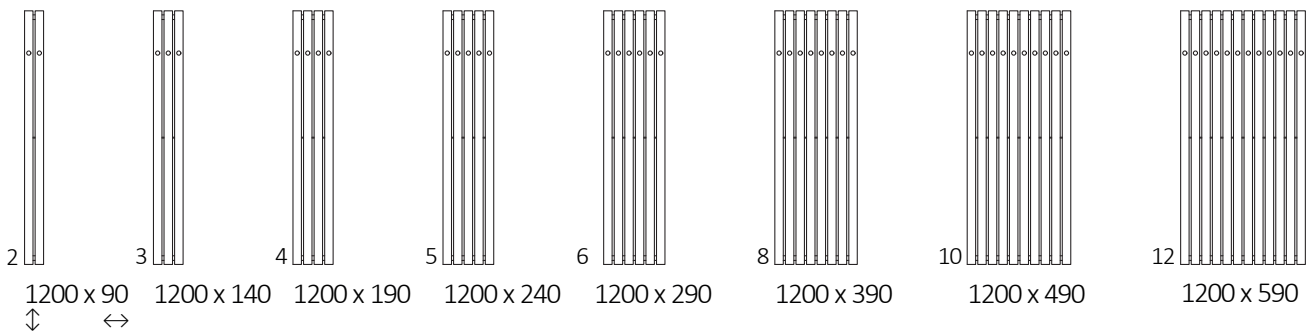





## CENTRAL HEATING

Height A ⇅ [mm]	Width B ↔ [mm]	Heating power			Product code <a href="#">... Configuration p. 12</a>
		75/65/20°C [W]	55/45/20°C [W]	 [W]	
1200	90	143,00	76,00	120	WGTHR120009
1200	140	214,00	114,00	200	WGTHR120014
1200	190	285,00	152,00	300	WGTHR120019
1200	240	356,00	190,00	400	WGTHR120024
1200	290	428,00	229,00	400	WGTHR120029
1200	390	570,00	305,00	600	WGTHR120039
1200	490	713,00	381,00	800	WGTHR120049
1200	590	855,00	457,00	800	WGTHR120059
1600	90	184,00	98,00	200	WGTHR160009
1600	140	276,00	147,00	300	WGTHR160014
1600	190	368,00	196,00	400	WGTHR160019
1600	240	460,00	245,00	400	WGTHR160024
1600	290	553,00	295,00	600	WGTHR160029
1600	390	737,00	393,00	800	WGTHR160039
1600	490	922,00	491,00	1 000	WGTHR160049
1600	590	1 106,00	589,00	1 000	WGTHR160059
1800	90	204,00	108,00	200	WGTHR180009
1800	140	306,00	163,00	300	WGTHR180014
1800	190	409,00	217,00	400	WGTHR180019
1800	240	512,00	272,00	600	WGTHR180024
1800	290	615,00	327,00	600	WGTHR180029
1800	390	820,00	436,00	800	WGTHR180039
1800	490	1 026,00	545,00	1 000	WGTHR180049
1800	590	1 231,00	654,00	1 200	WGTHR180059







Working pressure: 800 kPa

Maximum operating temperature: 95°C

Height A ⇅ [mm]	Width B ↔ [mm]	Spacing connection					Spacing horizontal fasteners D [mm]	Spacing vertical fasteners E [mm]	Bottom fasteners position F [mm]	Capacity  [dm <sup>3</sup> ]	Weight  [kg]
		C1 [mm]	C2 [mm]	C3 [mm]	C4 [mm]	C5 [mm]					
1200	90	50	50	1 140	90	500	50	1 020	90	2,88	3,96
1200	140	50	100	1 140	140	500	100	1 020	90	3,60	6,00
1200	190	50	150	1 140	190	500	150	1 020	90	4,81	8,03
1200	240	50	200	1 140	240	500	200	1 020	90	6,01	10,07
1200	290	50	250	1 140	290	500	250	1 020	90	7,21	12,10
1200	390	50	350	1 140	390	500	350	1 020	90	9,62	16,18
1200	490	50	450	1 140	490	500	450	1 020	90	12,02	20,25
1200	590	50	550	1 140	590	500	550	1 020	90	14,43	24,32

Height A ⇕ [mm]	Width B ↔ [mm]	Spacing connection C1 [mm]	Spacing connection C2 [mm]	Spacing connection C3 [mm]	Spacing connection C4 [mm]	Spacing connection C5 [mm]	Spacing horizontal fasteners D [mm]	Spacing vertical fasteners E [mm]	Bottom fasteners position F [mm]	Capacity  [dm <sup>3</sup> ]	Weight  [kg]
1600	90	50	50	1 540	90	500	50	1 420	90	3,20	5,23
1600	140	50	100	1 540	140	500	100	1 420	90	4,80	7,90
1600	190	50	150	1 540	190	500	150	1 420	90	6,40	10,57
1600	240	50	200	1 540	240	500	200	1 420	90	8,00	13,25
1600	290	50	250	1 540	290	500	250	1 420	90	9,61	15,92
1600	390	50	350	1 540	390	500	350	1 420	90	12,81	21,26
1600	490	50	450	1 540	490	500	450	1 420	90	16,01	26,60
1600	590	50	550	1 540	590	500	550	1 420	90	19,21	31,94
1800	90	50	50	1 740	90	500	50	1 620	90	3,60	5,87
1800	140	50	100	1 740	140	500	100	1 620	90	5,40	8,85
1800	190	50	150	1 740	190	500	150	1 620	90	7,20	11,84
1800	240	50	200	1 740	240	500	200	1 620	90	9,00	14,83
1800	290	50	250	1 740	290	500	250	1 620	90	10,80	17,82
1800	390	50	350	1 740	390	500	350	1 620	90	14,40	23,80
1800	490	50	450	1 740	490	500	450	1 620	90	18,01	29,78
1800	590	50	550	1 740	590	500	550	1 620	90	21,61	35,75

CONNECTION MATRIX

Product code	Size A ⇕ . B ↔ [mm]							
WGTRP120009	1200/90	✓	-	-	-	-	-	✓
WGTRP120014	1200/140	✓	-	-	-	✓	✓	✓
WGTRP120019	1200/190	✓	✓	✓	✓	✓	✓	✓
WGTRP120024	1200/240	✓	-	-	-	✓	✓	✓
WGTRP120029	1200/290	✓	✓	✓	✓	✓	✓	✓
WGTRP120039	1200/390	✓	✓	✓	✓	✓	✓	✓
WGTRP120049	1200/490	✓	✓	✓	✓	✓	✓	✓
WGTRP120059	1200/590	✓	✓	✓	✓	✓	✓	✓
WGTRP160009	1600/90	✓	-	-	-	-	-	✓
WGTRP160014	1600/140	✓	-	-	-	✓	✓	✓
WGTRP160019	1600/190	✓	✓	✓	✓	✓	✓	✓
WGTRP160024	1600/240	✓	✓	✓	✓	✓	✓	✓
WGTRP160029	1600/290	✓	✓	✓	✓	✓	✓	✓
WGTRP160039	1600/390	✓	✓	✓	✓	✓	✓	✓
WGTRP160049	1600/490	✓	✓	✓	✓	✓	✓	✓
WGTRP160059	1600/590	✓	✓	✓	✓	✓	✓	✓
WGTRP180009	1800/90	✓	-	-	-	-	-	✓
WGTRP180014	1800/140	✓	-	-	-	✓	✓	✓
WGTRP180019	1800/190	✓	✓	✓	✓	✓	✓	✓
WGTRP180024	1800/240	✓	✓	✓	✓	✓	✓	✓
WGTRP180029	1800/290	✓	✓	✓	✓	✓	✓	✓
WGTRP180039	1800/390	✓	✓	✓	✓	✓	✓	✓
WGTRP180049	1800/490	✓	✓	✓	✓	✓	✓	✓
WGTRP180059	1800/590	✓	✓	✓	✓	✓	✓	✓

TECHNICAL DRAWING

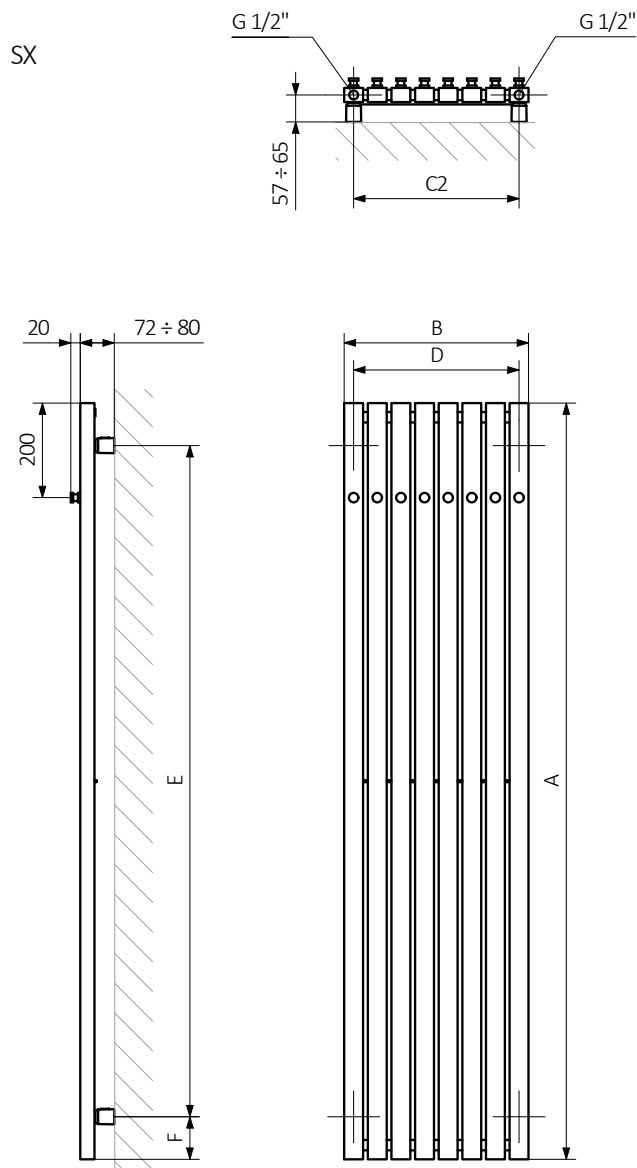

A – Height B – Width C1-C5 – Distance between pipe centres D – Horizontal distance between mounting bracket centres E – Vertical distance between mounting brackets F – Distance between a mounting bracket and the bottom of the radiator

Collector: Pipe:

